

**THE "AVO"
VALVE CHARACTERISTIC METER**

WORKING INSTRUCTIONS

THIRD EDITION



PUBLISHED BY

THE AUTOMATIC COIL WINDER & ELECTRICAL EQUIPMENT CO. LTD.

WINDER HOUSE, DOUGLAS STREET, LONDON, S.W.1

Telephone : VICToria 3404-9



THE AVO VALVE CHARACTERISTIC METER Mk II

FOREWORD

FOR more than a quarter of a century we have been engaged in the design and manufacture of "AVO" Electrical Measuring Instruments. Throughout that time we have consistently pioneered the design of modern multi-range instruments and have kept abreast of and catered for the requirements of the epoch-making developments in the fields of radio and electronics.

The success of our steadfast policy of maintaining high standards of performance in instruments of unexcelled accuracy, and making such instruments available at reasonable cost, is reflected in the great respect and genuine goodwill which "AVO" products enjoy in every part of the World.

It has been gratifying to note the very large number of instances where the satisfaction obtained from the performance of one of our instruments has led to the automatic choice of other instruments from the "AVO" range. This process, having continued over a long period of years, has resulted in virtual standardisation on our products by numerous Public Bodies, The Services, Railway Systems, and Post Office and Telegraph Undertakings throughout the world.

Our designers have thereby been encouraged to ensure that new instruments or accessories for inclusion in the "AVO" range fit in with existing "AVO" apparatus and serve to extend the usefulness of instruments already in use. Thus, the user who standardises on "AVO" products will seldom find himself short of essential measuring equipment, for, by means of suitable accessories, his existing equipment can often be adapted to meet unusual demands.

It is with pleasure that we acknowledge that the unique position attained by "AVO" is due in no small measure to the co-operation of so many users who stimulate our Research and Development staffs from time to time with suggestions, criticisms, and even requests for the production of entirely new instruments or accessories. It is our desire to encourage and preserve this relationship between those who use "AVO" Instruments and those who are responsible for their design and manufacture, and correspondence is therefore welcomed, whilst suggestions will receive prompt and sympathetic consideration.

INDEX

Foreword	3
Introduction	5
The Basic Method of characteristic checking	7
The Basic Method of checking diodes and rectifiers	7
Insulation Testing	8
The Safety Cut-out	9
The Valve Panel and Selector Switch	9
Procedure for setting up valve base connections	10
Provision for new valve bases	12
The prevention of Self oscillation of valves under test.. .. .	12
Diagram of Standard base pin connections	13
Special procedure for valves having internally connected pins	14
The controls on the front panel, their functions and operations	15
The Set \sim Control	16
The Electrode Leakage Switch	16
The Circuit Selector Switch	16
The Anode and Screen Voltage Switches	17
The Heater Voltage Switches	17
The Negative Grid Voltage Control	17
The Press Buttons	17
The Set Zero Control	17
The Meter Selector Switch	18
The Set mA/V Control	18
The Anode Selector Switch	18
The Special Adjustment Panel at the rear of the instrument	19
General Procedure for testing a valve	19
Mains voltage adjustment and panel set up—cold and hot leakage tests—mutual characteristic checks and gas tests—diode and rectifier tests made under load.	
Instructions for testing specific valve types	22
Multiple diodes and rectifiers—double triodes and double pentodes—combined diode and amplifying valves—frequency changers of heptode and hexode types—frequency changers employing separate electrode assemblies.	
The Use of the Link on the Back Panel of the Instrument	24
Tuning Indicators	24
Gaseous Rectifiers	24
Cold Cathode Rectifiers	24
Thyratrons	24
Neon Indicators	25
General Precautions to be observed when using the Valve Characteristic Meter	25
Notes upon simple maintenance of instrument	26
Circuit diagram of Valve Characteristic Meter	27

The "AVO" Valve Data Manual

This instrument will produce maximum information when used in conjunction with the Valve Manufacturer's Graphs and Technical Data, but to enable rapid checks to be made relative to a valve's general efficiency, the "AVO" Valve Data Manual has been produced.

This instruction book refers throughout to the "AVO" Valve Data Manual, a copy of which should always be kept with the instrument. New editions of this data manual will be published from time to time. Watch our advertisements in the technical press for further announcements.

Introduction
to
THE "AVO" VALVE CHARACTERISTIC METER

The problem of designing a Valve Testing Instrument capable of giving a true and comprehensive picture of the state of any valve, has always been one of considerable magnitude, increasing in complexity as new valve types are brought into general use.

For a quick general purpose test necessitating a minimum of time and technical effort, a mutual conductance figure will give an adequate idea of a valve's usefulness, and the original "AVO" Valve Tester was designed to test the efficiency of valves on this basis.

Whilst a Valve Tester must, of necessity, be accompanied by a data book correlating the results of the Tester with the condition of the valve in question, a purely empirical figure, if used as a standard, will always give rise to doubts in the mind of the operator. The instrument should therefore, produce a figure which can be compared with some standard quoted by the valve manufacturer, if the operator is to use his instrument with confidence. For this reason the "AVO" Valve Tester used the static zero bias mutual conductance figure as a basis of comparison, this figure being at that time almost universally quoted by the valve manufacturer.

In order to reproduce this standard correctly, it was also necessary to reproduce the stated values of DC anode and screen voltage, a matter of some considerable difficulty when it is realised that for any stated condition of anode and/or screen volts the corresponding electrode currents can vary over very wide limits, and in the case of valves of low initial anode current and high slope, the actuation of the control which produces the milliamp-per-volt reading might easily double the anode current flowing. With D.C. methods of testing the inherent internal resistance of the rectifying circuits used could be such as to give regulation errors which could cause results to be meaningless unless complicated thermionic stabilising circuits and a vast array of monitoring meters were used in all voltage supply circuits. Such complications would not only render the Tester of prohibitive price and size, but would considerably increase the complication of operation for the non-technical user.

The problem was overcome by the introduction of the AC method of operation (Patent No. 480752) by which means the necessary DC test conditions were correctly simulated and a true mutual conductance figure produced by the application of AC voltages of suitable amplitude to all electrodes. This enormously simplified the power supply problem, rendered regulation errors negligible, and obviated the necessity for voltage circuit monitoring.

The "AVO" Valve Tester thus fulfilled normal testing needs for a long period. During recent years, however, electronic techniques have become much more precise and the nature and multiplicity of valve types have continuously increased. The zero bias mutual conductance figure is seldom quoted by the valve manufacturers, who, usually, publish the optimum working point mutual conductance and voltage figures, and in a large number of cases give full families of curves, from which, precise operation, under a variety of working conditions, can be judged. To cater for present day requirements therefore, a valve testing device should not only be capable of producing a working point mutual conductance figure at any reasonable value of anode, screen or grid voltage recommended by the manufacturers, but should also be capable, if necessary, of reproducing any one of the mutual characteristics associated with the valve in question. The instrument thus has to simulate the performance of a comprehensive valve measuring set-up of laboratory

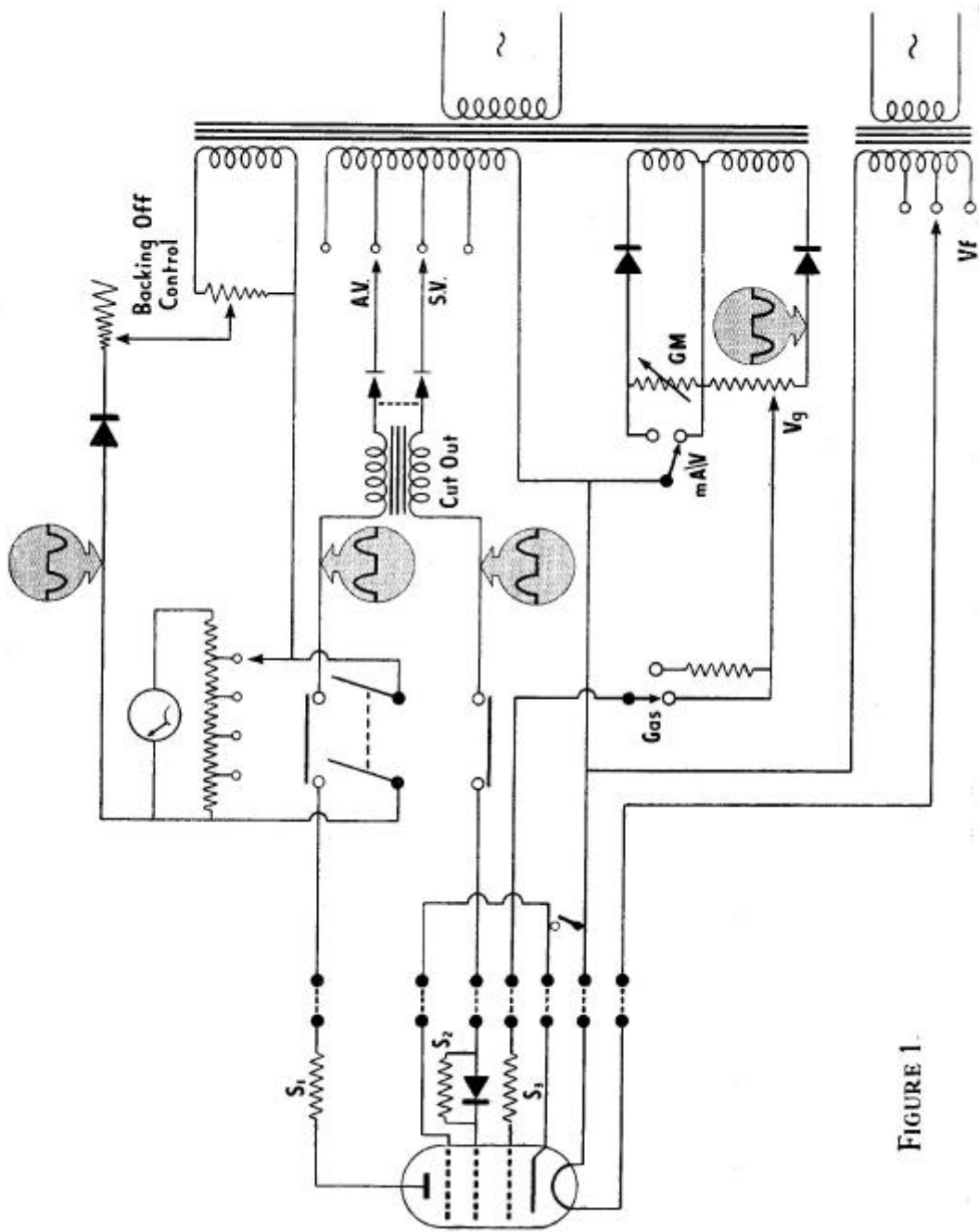

FIGURE 1.

type and yet, at the same time, be sufficiently cheap and simple to cater for the needs of the comparatively inexperienced radio test assistant. It is obvious that the very much wider application of an instrument of this class, would render the regulation difficulties, already referred to, much more critical.

Investigations were, therefore, put in hand to see whether the AC test method would reproduce DC conditions not only in respect of the mutual conductance figure taken at a single discrete point, but at all points on all characteristics from zero bias to cut off. In other words, it was necessary to determine whether the general function for a DC static valve characteristic

$$I_a = f \frac{(V_a + \mu_1 V_{g_1} + \mu_2 V_{g_2})}{R_a}$$

would hold when I_a was measured in terms of DC current, but when V_a , V_{g_2} and, if necessary, V_{g_1} , were replaced by 50 cycle AC voltages of suitable magnitude. It was eventually found that a complete co-relation between these two sets of conditions was held when the grid voltage took the form of a sinusoidal wave form with the positive half cycle suppressed (in other words, rectified but completely unsmoothed AC), and the following relationships were maintained :—

$$\begin{aligned} V_a \text{ RMS} &= 1.1 V_a \text{ indicated DC} \\ V_{g_2} \text{ RMS} &= 1.1 V_{g_2} \text{ indicated DC} \\ V_{g_1} \text{ (mean unsmoothed)} &= 0.52 V_{g_1} \text{ indicated DC} \\ I_a \text{ (mean DC)} &= 0.5 \text{ indicated } I_a \end{aligned}$$

From the above conditions, therefore, the required relationships were obtained which formed the basis of operation of the Valve Characteristic Meter (Patent No. 606707).

Such an instrument, whilst retaining the advantages of simplicity, size and reasonable price, resultant upon the elimination of complicated regulated DC supply systems and universal monitoring, would have the inherent regulation easily obtained from a well-designed AC transformer. It would enable a valve to be checked at any point on any one of its many mutual characteristics and if necessary would allow a full family of characteristics to be drawn.

The basic method of characteristic checking

The fundamental circuit of operation of the instrument is shown in Figure 1, the nature of the wave forms present in the various parts of the circuit being indicated thereon. As in the original Valve Tester, the process of obtaining a direct reading mutual conductance figure is simplified by the production of a backing off circuit, which balances out the deflection due to the standing anode current at the desired test conditions prior to the operation of the mutual conductance button. Only the desired figure appears on the meter scale, thus enabling the meter to be set at a sufficiently sensitive range for precise determination of mutual conductance. It will be noticed that the current flowing in this backing off circuit is similar in wave form, but precisely opposite in direction to the anode current, thus eliminating any undesirable ripple that could otherwise become apparent when the meter, after backing off, was set to a sensitive range.

The basic method of checking diodes and rectifiers

Any simple emission test at low applied voltage must necessarily give rise to a purely empirical figure for the valve in question which cannot necessarily be co-related with any one of the maker's characteristics and which, owing to the fact that it relates to the lower bend portion of the rectifier characteristic may vary very widely for any given type of valve.

The important function of a rectifying valve is that it will, under suitable reservoir load conditions, produce sufficient current to operate the apparatus which it is intended to supply. This fundamental requirement, therefore, is the basis of rectifier testing in the Valve Characteristic Meter. A sufficiently high AC voltage is applied to operate the valve above the bend in its characteristic, and to ensure that its internal voltage drop is negligible. With a suitable reservoir condenser in circuit, the DC load is adjusted to correspond to a number of DC current conditions, i.e. 5mA, 15mA, 30mA, 60mA and 120mA. The actual current flowing in the load circuit is then indicated on a meter shunted to correspond with the DC load required. The meter reading will then indicate as a percentage, the comparative efficiency of the valve on the basis of this required DC load. Each half of a full wave rectifying valve is tested separately thus enabling matching of two halves to be checked and any tendency to produce hum by partial half waving to be indicated.

The pre-determined load figures are chosen so that they not only give a sufficiently wide range of currents to cater for the normal requirements of electronic apparatus, but also correspond to the DC maximum emission figures usually quoted by manufacturers in their rectifying valve data. Signal diode valves are similarly tested, but a lower AC voltage is applied and comparison is made with a single DC load figure of 1mA, this figure being normally more than sufficient to cover the rectified signal current that would be obtained. The basic operating circuit of the diode and rectifier system is shown in Figure 2.

Insulation Testing

To cover all eventualities, three distinct forms of insulation measurement are catered for in the Valve Characteristic Meter. Measurements are taken with DC applied voltages, and direct indication of the insulation value in megohms is shown on the meter scale. As an initial test, prior to the application of operating voltages to the valve, the rotation of a switch enables the insulation figure to be shown, which occurs between each of the valve electrodes taken in order and all the others strapped together. The denomination of the

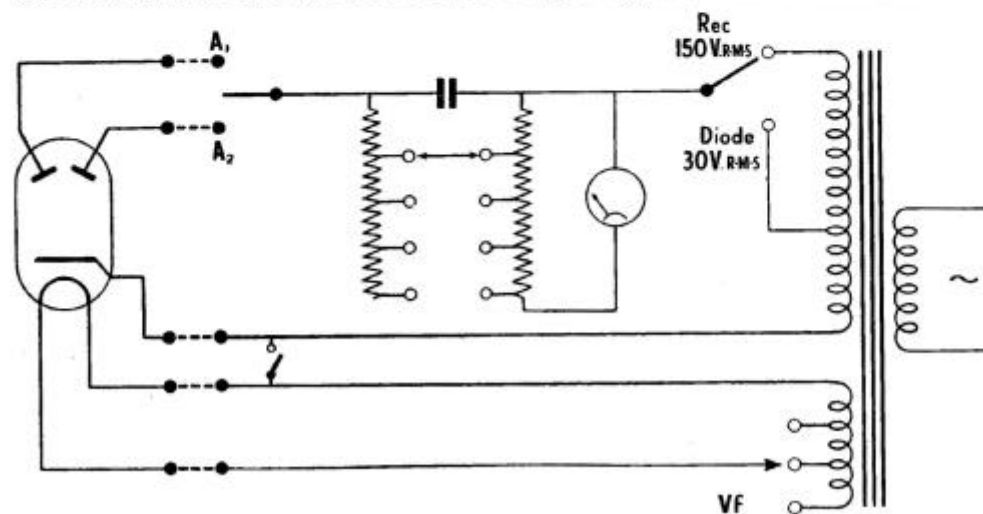

FIGURE 2

electrodes between which any breakdown exists will thus be automatically indicated and further, the continuity of the heater circuit is shown as a zero resistance at the heater (H) position of the switch.

With directly heated valves it is not uncommon for electrode sagging to occur on the application of heater voltage, with the result that a breakdown occurs between heater and an adjacent electrode. To show up this condition a test circuit is provided indicating the insulation resistance between the heater and cathode of a valve and all other electrodes strapped when heater voltage has been applied.

Finally the very important factor of heater to cathode insulation when the heater is hot can be tested, the insulation again being shown directly in megohms, the usual cathode to heater connection being opened for this purpose and the applied voltage being in such a direction as to make the cathode negative with respect to the heater, thus avoiding false indications of insulation resistance due to electrode emission.

Safety Cut-Out

To prevent damage to internal components of the Valve Characteristic Meter, due to inadvertent or deliberate shorting of the supply voltages, a safety cut-out is incorporated, operative when damaging overloads of AC current are taken from either the anode or screen voltage sources. The cut-out takes the form of a two circuit polarised electro-magnetic relay which has two windings incorporated in its electro-magnetic system, one associated with the screen voltage supply and one with the anode voltage supply. It will be appreciated that with the valve electrodes taking normal current, half wave DC pulses only will flow through these windings and the direction and magnitude of the windings are such that with anode current only flowing, or alternatively, with a considerably larger anode current than screen current flowing, the cut-out will be held in contact and the instrument will work normally. It is obvious, however, that if an internal valve short occurs on any one of its high voltage electrodes, or alternatively, if such a short is applied externally via the valve holder sockets, or other part of the circuit, or further if any internal short occurs associated with the anode or screen supply circuits, then the current flowing in these circuits will not take the form of uni-directional pulses, but will be ordinary AC current.

In such circumstances, the effect of the first half cycle of AC current in the reverse direction from normal will be such as throw out the cut-out and thus break both anode and screen supply circuits. The overload is, therefore, removed from the supply system and burn out of transformers and associate parts is obviated. Note that this protection does not apply in the case of a short applied to the heater voltage windings as these normally pass sinusoidal AC current. Further, if for any reason when testing a pentode the anode circuit should become disconnected (this can occur when the roller switch is wrongly set up) then the normal result would be for a damagingly heavy rectified current to flow in the screen circuit ; the relative direction and magnitude of the two windings on the cut-out is then such that when the current in the screen circuit seriously exceeds the current in the anode circuit the cut-out is thrown and damage both to valve and circuit is obviated. *It must be stressed that this cut-out will not operate upon the passage of normal heavy currents of a DC nature occurring in the valve anode circuit, and it will not protect the movement if the latter is wrongly set on a range not corresponding to the current passing. This problem is dealt with by ensuring that the movement is always set to its maximum current range when the probable magnitude of the current is unknown.*

THE VALVE PANEL AND SELECTOR SWITCH

The Valve Panel comprises 18 valve holders of the following types :—English—4/5 pin, 7 and 9 pin, 8 pin side contact, B7G, B8A, B8B (American Loctal), B9G, English Octal,

B3G, 4 and 5 pin Hivac : American—4, 5, 6 and small 7 pin UX, medium 7 pin UX, Octal, and B9A. Provision is made by means of plug-in adaptors to cater for newly introduced valve bases. These valve holders are all wired with their corresponding pins, according to the standard pin numbering, in parallel, i.e. all pins number one are wired together, all pins number two, and so on. This wiring combination is associated with the well-known "AVO" Multi-Way Selector Switch which enables any one of the nine standard pin numbers to be connected to any one of the electrode test circuits in the Valve Characteristic Meter proper, thus enabling any electrode combination to be set up for any normal valve holder.

It will be seen that the Selector Switch comprises nine thumb control rollers, numbered from left to right 1—9. This numbering appears on the moulded escutcheon immediately behind the rollers and corresponds to the valve pins in the order of their standard pin numbering. Thus valves with any number of base connections up to nine can be accommodated. Further, to accommodate top cap and other external valve connections a socket panel is provided with five sockets marked G1, S, A1, A2, D1 the markings corresponding to the valve electrode connection which is made externally to the valve.

Rotation of the rollers by the finger rim provided will reveal that each roller can be set in any one of ten positions, the setting in question being indicated in the window opening at the front of the escutcheon. The ten positions on the roller are marked as under :—

	1	2	3	4	5	6	7	8	9	0
	C	H—	H+	G	S	A	A2	D1	D2	E

The numbers are provided for ease of memorising and noting base combinations, but the corresponding electrode denominations are shown by the letter appearing in the escutcheon window immediately underneath the number, thus :—

- (1) C corresponds to Cathode.
- (2) H— " " Heater normally Earthy or connected to negative L.T. in the case of a battery valve.
- (3) H+ " " the other Heater connection or centre tap.
- (4) G " " Control Grid.
- (5) S " " Screen Grid or g_2 .
- (6) A " " normal anode of single or multiple valve. In the case of an Oscillator mixer valve, A represents the Oscillator anode.
- (7) A2 " " second anode of double valves, and in the case of Oscillator mixer valves, the mixer anode.
- (8) D1 " " the first diode anode of half and full wave signal diode and rectifier valves, diode and rectifier/amplifier combinations.
- (9) D2 " " the second diode anode of signal diode and rectifier valves, diode and rectifier/amplifier combinations.
- (0) E " " any earthed screen or screening electrode not operating under applied voltage conditions nor normally connected to cathode.

Procedure for setting up valve base connections

The standard procedure for setting up a valve ready for test is as follows. From some suitable source i.e. "AVO" Valve Data Manual, Valve Manufacturer's Data Leaflet or published manual of Valve Data, determine the pin basing connections for the valve, in order of their standard pin numbering. Rotate the rollers of the Selector Switch until the set up number or electrode letter combination appears in the window reading from left to right in order of the standard pin numbering. In the case of valves having less than nine pins, the free rollers on the right of the set up combinations corresponding to non-existent valve

electrodes should be set at O(E). Insert the valve in the appropriate valve holder. With one of the leads provided connect any top cap or side connection on the valve to its appropriately marked socket, on the Socket Panel immediately above the Selector Switch. Note that the loctal valve holder having only eight normal electrodes has its centre lug connected to the ninth roller (corresponding to pin No. 9) to accommodate valves which have a cathode connection made to this lug.

The accompanying examples show how to co-relate the pin basing data and the equivalent set-up combination for a number of valves in common use.

Valve Type	Set up Number								Base Diagram	
1. Osram MH4 indirectly heated triode. British 5-pin base.	6	4	2	3	1	0	0	0	0	
2. Osram U50 full wave rectifier directly heated. Octal base.	0	2	0	8	0	9	0	3	0	
3. Mullard PenA4 indirectly heated output pentode. British 7 pin base.	0	4	5	2	3	1	6	0	0	
4. American 6K8 indirectly heated frequency changer. Octal base. Top Cap G1.	0	2	7	5	4	6	3	1	0	
5. Mullard TDD2A battery double diode triode. British 5-pin base. Top Cap G1.	6	8	2	3	9	0	0	0	0	
6. Mullard EF50 indirectly heated HF pentode. B9G base.	2	5	6	1	0	1	4	0	3	

Provision for New Valve Bases

To cover the possibility of the introduction of new valve bases not provided for on the standard panel and also the introduction of valves which may necessitate special conditions associated with standard valve holders, a plug-in adaptor is available which enables any non-standard valve holder to be combined in this adaptor and plugged into the octal or other suitable base on the Valve Characteristic Panel. These adaptors are available for bases not included on the Valve Panel, and also with a blank valve holder mounting panel in which can be mounted the user's own valve holder if he requires any special arrangement for which we have not catered.

The Prevention of Self Oscillation of valves under test

It will be realised that the length of wiring and its associated capacity, connected to the grid and anode pins of any one of the valve holders, can constitute a tuned line corresponding to a high resonant frequency often of the order of 100 megacycles per second or higher. A number of modern valves have sufficiently high slope to overcome the inherent losses associated with such a tuned line, and are, therefore, capable of bursting into oscillation at a frequency determined by the constants of their associated valve holder wiring when being tested at or near their maximum working slope. It is quite obvious that in order to test a valve some wiring must exist between the valve holder and test circuit. Further, since a multiple test panel is desirable to obviate the necessity of a vast number of separate plug-in units, the total amount of wiring associated with any one valve holder must be a considerable number of inches in length. It is almost impossible to increase the effective resonant frequency of the lines thus produced to such a high value that no normal valve will oscillate therewith. The only alternative is to render the line of comparatively high loss and in extreme cases to stopper the valve in question right on top of its anode and/or grid connection. Unfortunately, however, since a very large number of pin combinations have to be accommodated in any one valve holder the presence of such a resistance in say a heater or cathode circuit could give completely erroneous results, and this stoppering system could therefore only be very sparsely used.

In certain circumstances where a newly introduced valve of high efficiency is likely to be tested in any quantity and shows signs of oscillation, the separate valve holder adaptor can be employed with considerable advantage. By this means a valve holder can be stoppered to the maximum extent necessary for the valve in question without reference to any other valves that may be incorporated therein, as when the other types of valves are likely to be used, the adaptor can be set aside and the valve panel used normally. It must be stressed that this oscillation is unlikely to occur where the valve is tested at anode currents lower than normal, or at a point on its curve which renders its mutual conductance low. Were a purely empirical method of testing employed in the Valve Characteristic Meter, therefore, the problem would in all probability not arise, but since every effort has been made to actually test the valve under its correct operating conditions of current and voltage, then it is on this account working at its normal efficiency and can, unless special precautions are taken, give rise to the oscillation troubles to which we have referred.

Whilst discussing the problem of oscillation, mention should be made of the rectifier (which will be seen in the circuit diagram) included in the screen circuit of pentode and tetrode valves. This rectifier has been incorporated to obviate a difficulty which can arise in certain circumstances when testing valves of the beam tetrode type with alternating current applied to their electrodes. As the applied electrode voltages approach zero during a portion of their operative cycle, the focusing of the beam of such valves is to some extent upset and the result can be that the screen circuit begins to show an

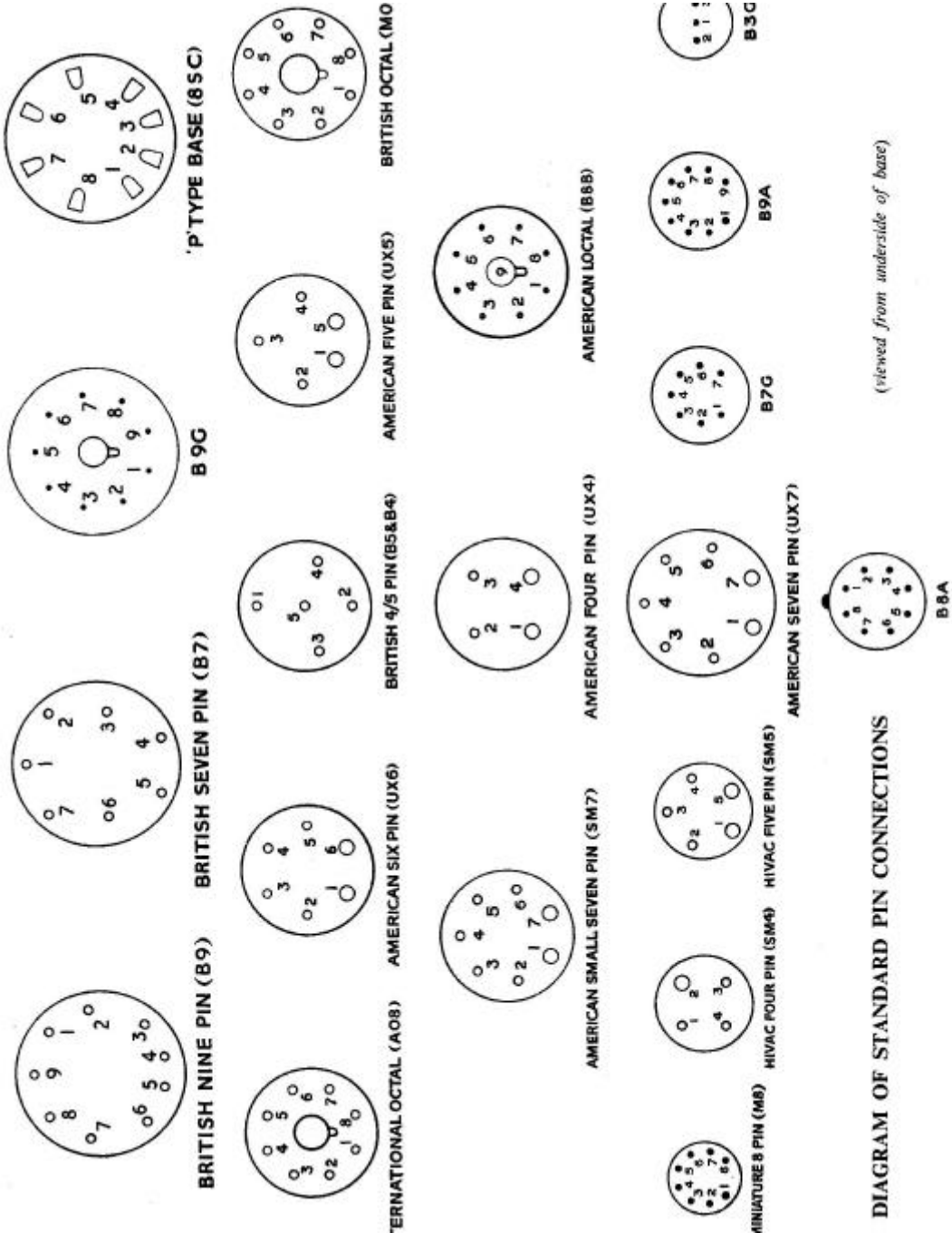

(viewed from underside of base)

DIAGRAM OF STANDARD PIN CONNECTIONS

emission in a reverse direction to normal screen current with the result that the anode current rises and the current taken by the screen decreases rapidly and becomes negative. This can cause screen overheating and besides giving an unstable and erroneous impression of the condition of the valve, can, if allowed to continue, damage the valve. To obviate this condition, therefore, the rectifier is included in such a manner that only its low forward resistance is presented to the screen passing current in the normal direction, thus causing a negligible variation to standard conditions, but the reverse resistance of the rectifier is operative to limit screen current of the opposite direction to negligible proportions and thus prevent the conditions stated above, from coming into effect.

The problem of self oscillation has been almost completely eliminated in the "AVO" Valve Characteristic Meter Mark II by stoppering the Roller Selector Switch, and wiring the Valve Holder Panel in connection loops of predetermined lengths, so that any valve inserted would tend to oscillate at a definite frequency dependent on the loop lengths. These separate inter-connection loops are then loaded so that oscillation cannot occur when testing valves with conventional characteristics, irrespective of the Valve Holder and pin combination used. In earlier models, every attempt has been made to reduce the possibility of oscillation by the discreet use of stoppers wherever possible and the careful lay out of wiring in cases where it is known that high slope valves are likely to give rise to trouble of this nature.

Special procedure for Valves having Internally Connected Pins

The notes which follow relating to valves having internally connected pins do not apply to the Valve Characteristic Meter Mark II and can be ignored. Here where * appears in the Selector Switch number, denoting an internal connection, it is merely necessary to set the appropriate Roller to $\frac{0}{9}$, e.g. U.81 where the Selector Switch reads **9 **8 230 set the Roller Selector Switch to read 009 008 230 and test as a normal valve.

On certain valves of recent manufacture, particularly the miniature glass type employing B7G, B8A, B9A, etc., bases it has become the practice of manufacturers to connect internally certain of the valve electrodes to pins which would otherwise be blank and free from any connection. Although the manufacturers specify the pins on which this is likely to occur they reserve the right to vary the nature of the internal connections from time to time as prevailing conditions might demand. This in itself prevents the inclusion of the electrode thus internally connected, in the normal selector switch set-up of the valve.

The pins on which this arrangement occurs however, cannot be connected to earth (O) on the roller switch, for this may result in an electrode being shorted to earth with possible damage to the instrument. Therefore, where this possibility is known to exist a symbol "*" appears in place of the relevant pin connection in the valve set up number, (see "AVO" Valve Data Manual) to ensure that the preliminary test for electrode insulation is carefully carried out before normal test procedure is brought into effect.

Where "*" appears in the set up number substitute $\frac{1}{C}$ when setting up the selector switch. Before inserting valve, ensure that **Circuit Selector** switch is in position **Check (C)** and apply the normal Electrode Leakage Test. This will enable the unknown electrode connection to be obtained as follows :—

- (1) By rotating the **Electrode Leakage** switch, a "short" will appear at the position "C" in addition to one or more other electrode positions, depending on the number of internal connections. If now the rollers associated with the valve pins designated

by “ * ” ($\frac{1}{C}$ in the set up) are rotated, the short will be cleared when the roller(s) electrode indication is the same as the electrode to which the pin(s) in question is internally connected. The final set up which clears all shorts will obviously be the correct one for the valves and normal testing can thus proceed.

e.g. if set up reads 41236*100
Set rollers to read 412361100

On proceeding as above, it is found that a short occurs on “ C ” and “ G ” positions of **Electrode Leakage** switch : On rotating roller No. 6 to $\frac{4}{G}$, when the set up reads 412364100, the indication of shorts will have been removed and normal test procedure can be followed.

This method will satisfactorily deal with all internal electrode connections (A, S, G, etc.) with the exception of the case where the internal connection is made to a point on the heater (this may be either end or centre tap).

- (2) In such a case, a short will appear at the “ C ” position of the **Electrode Leakage** switch, but at no other electrode position (as “ H ” position normally shows short circuit denoting heater continuity). Rotating the corresponding roller in this case will merely change the “ short ” indication to some other electrode designated by the roller position.

Remove the valve from its socket and carry out a continuity test with an ordinary ohmmeter between the pin on which the unknown connection occurs and all standard pins connected to heater. The ohmmeter must be used on a low enough range to distinguish between “ short ” and the heater resistance. The point on the heater (H —, H+ or CT) showing zero resistance to the pin in question will now determine the set up number, and the roller must be rotated accordingly.

E.g. If set up is 41236*100

and on ohmmeter check, zero resistance is shown between pins 6 and 3, set up for all tests will be 412362100.

It should be noted that if after switching to **Check (H)** the indicator lamps are very dim, and valve heater does not light up, it is probable that the valve filament voltage is being shorted out, due to the wrong side of filament voltage being connected to the internal connection pin, and this fault can be cleared by reversing the heater connection to the pin marked “ * ”.

- (3) When no indication of electrode leakage, other than normal heater continuity, occurs at any position of **Electrode Leakage** switch, the pin(s) marked “ * ” have not been connected internally and normal procedure can be followed in testing the valve, the roller position marked “ * ” being set at “ $\frac{0}{E}$ ”.

THE CONTROLS ON THE FRONT PANEL THEIR FUNCTIONS AND OPERATIONS

All the controls necessary for carrying out the essential valve testing functions are situated on the front panel of the instrument, and by the manipulation of these controls and the use of the valve panel already described, the following tests can be undertaken.

1. The direct indication of insulation resistance between electrodes with the valve cold. This test will also indicate heater continuity.
2. The direct indication of insulation resistance between specific electrodes with the valve filament hot, including a separate test for the important function of cathode to heater insulation.
3. The measurement of mutual conductance directly in milliamps/volt over a full range of applied high tension and bias voltages.

4. The comparative indication of valve goodness on a coloured scale on the basis of mutual conductance reading.
5. The ability to plot complete sets of mutual characteristics I_a/V_{g_1} , I_a/V_a , I_a/V_{g_1} , I_s/V_s , etc., with a complete range of applied electrode voltages corresponding to D.C. operating conditions.
6. The testing of rectifiers under reservoir condenser conditions with a full range of D.C. loading.
7. The testing of signal diodes under suitable D.C. load.
8. The testing of the separate sections of multiple valves, the non-operative section of the valve being maintained at reasonable working electrode voltages.
9. The indication of grid current and valve softness.
10. The possibility of testing valves with suitable loads included in the anode or other required electrode circuit, together with the ability to read the required electrode current on a separate meter of greater sensitivity if desirable, thus rendering the instrument suitable for making tests on non-standard and specialised types of valves not catered for in the normal circuit arrangements.

The separate functions of the controls available are as follows :—

The Set ~ Control.

This control enables minor adjustments to be made to the input tapplings on the mains transformer after the coarse mains tapping has been set.

The Electrode Leakage Switch

This switch serves the dual purpose of putting the instrument in a condition for the initial setting of the Set ~ control and also indicates the electrodes, if any, between which leakage occurs with the valve in a cold condition. It also serves to indicate heater continuity.

The Circuit Selector Switch

This is a six position switch enabling the instrument to be set up in readiness for the type of test to be undertaken. All the necessary internal circuit connections are made to satisfy the test conditions required, whilst internal test circuits, unnecessary to the measurements in question are automatically removed from the valve.

On position **Check (C)** the instrument is set up for the initial mains voltage adjustment, also on the same position the Tester is suitably connected for the cold electrode leakage test, to which we have already referred.

At the **Check (H)** position of the switch, the valve is automatically tested for electrode leakage, with the heater hot, between the cathode and heater strapped, and all other electrodes.

At position **C/H. ins** the valve is automatically tested for cathode to heater insulation with the valve hot.

With the circuit selector turned to **Test** all normal mutual characteristics are measured in conjunction with the electrode voltage controls, the meter and anode selector switches and other relevant controls. It will be noted that in the case of the insulation tests the meter is automatically shunted to the appropriate sensitivity and the insulation scale can be read directly. On the **Test** position of the **Circuit Selector** switch, however, the meter range selector is brought into circuit, thus enabling the meter range to be suited to the current measurement to be undertaken.

The switch setting **Diode** and **Rec** are for carrying out reservoir load tests on diodes and rectifiers, respectively. In the case of the diode test the **Meter Selector** should be set to the 1mA position, whilst when testing rectifiers the **Meter Selector** is set to a value, on the inner scale, suited to the load on which it is desired the rectifier should be tested.

The Anode and Screen Voltage Switches

As their names imply these switches enable the requisite electrode voltages to be applied to screens and anodes of valves for the purpose of carrying out mutual characteristic measurements. They are normally calibrated in the equivalent DC voltage settings and, therefore, no account need be taken of the actual value of AC voltage which appears at the electrodes of the valve, which, as already explained, will differ from the equivalent DC value marked at the switch position.

The Heater Voltage Switches

This dual switch combination is for adjustment of the heater voltage applied to the valve under test. To enable a very wide range of heater voltages to be obtained the settings of the two switches are arranged to be additive. Thus, with the right hand switch set at 0 all useful voltages between 1.1 and 16 can be applied to the valve by the left hand switch, whilst with the right hand switch at any figure above 0 the value indicated on the right hand switch should be added to the indication of the left hand switch. For example, with the left hand switch set at 5 and the right hand switch at 80, the heater voltage applied to the valve will be 85.

The Negative Grid Voltage Control

A continuously variable control calibrated 0—10 and marked **Neg Grid Volts** enables the initial negative bias at which a test is made, to be set at any value between 0 and — 10 volts, with the bias multiplier switch set at $V_g \times 1$. With this switch set at $V_g \times 10$ the bias range covered by this control is increased to 0—100V negative.

The Press Buttons

Immediately underneath the movement will be found a row of three buttons marked respectively **Gas**, **Re-Set** and **mA/V**. As their names imply these are for the indication of grid current, the re-setting of the automatic cut-out, and the direct reading of mutual conductance in mA/V after the initial valve test conditions have been set.

The **mA/V** button applies a small supplementary change of grid bias in a positive direction to the grid of the valve after the latter has been correctly set up in accordance with the data given in the "AVO" Valve Data Manual or alternatively, with the maker's characteristic details. The initial anode current having been obtained and the meter indication backed off by the backing off control, the pressing of this button will cause a rise in the anode current which will indicate on the appropriate meter scale the mutual conductance of the valve directly in mA/V. This test also serves as a comparison test of valve goodness in conjunction with the coloured meter scale and **Set mA/V** control.

A change in anode current consequent upon the pressing of the **Gas** button will indicate the presence of grid current in the valve, the relative magnitude of which can be assessed from a knowledge of the mutual conductance of the valve and the change in current obtained.

When the presence of a damaging short causes the cut-out to operate, the lamps behind the meter will be extinguished and voltages will be removed from anode and screen circuits of the valve. After having investigated and removed the cause of the short the instrument may be put into operation again by the pressing of the **Re-Set** button, the correct condition being shown by the illumination once again appearing behind the meter scale plate.

The **Set Zero Control** enables an initial anode current reading for the valve to be backed off prior to the taking of mutual conductance readings, the direction of the control being

such that an anti-clockwise movement of the knob will cause the meter needle to approach zero.

The **Meter Selector Switch** is a combination switch serving to shunt the meter suitably to the current measurement to be undertaken and also to insert the right value of load when making tests on rectifiers and diodes. It has two sets of calibrations, the outer ring of figures marked 100, 25, 10, 2.5 and mA/V is for use when the current selector is at position **Test**, and serves to indicate the full scale deflection current for the movement in milliamps when taking anode current figures, and similarly represents full scale reading in mA/V when taking mutual conductance figures. The last position marked mA/V indicates that the instrument is correctly switched for the use of the mA/V Control in conjunction with the coloured comparison scale on the meter.

The inner ring of figures marked 120, 60, 30, 15, 5, 1 represent the load current associated with the coloured scale when taking rectifier tests with the circuit selector on **Rec** or **Diode**. Thus if the valve is rated at say 60 mA per anode, the **Meter Selector Switch** should be turned to "60" on the inner ring of figures and the comparative goodness of the valve with reference to this basic figure will be shown on the coloured scale.

Note that when the **Circuit Selector** switch is set to **Diode** for testing signal diodes, the **Meter Selector** should always be turned to position "1" and the coloured scale then operates with reference to a load current at 1mA, a suitable figure for signal diodes. The 1mA setting of the **Meter Selector** does not apply to rectifier load tests with the **Circuit Selector** switch at **Rec**.

The **Set mA/V Control**, marked 1—15mA/V is for the rapid checking of the operative goodness of a valve on the basis of mutual conductance, after the valve has been set up for normal test, and the anode current backed off to zero. After the **Meter Selector** is turned to position mA/V, the mA/V Control should be turned to the rated mutual conductance figure for the valve in question. The pressing of the mA/V button will now cause the meter needle to rise and its position on the coloured scale will denote operative valve goodness.

The **Anode Selector Switch** marked A₁, A₂, S, enables separate tests to be made on multiple valves, and also makes possible the taking of Screen (or g₂) characteristics. With this switch turned to "A₁", the figures of anode current and mutual conductance shown on the meter are relevant to the anode designated on the set up roller by $\frac{6}{A_1}$. As such the switch is in position for measurements on all single electrode system valves (triodes, pentodes, etc.). This position also serves for the first half of double valves (double triodes etc.) and for the triode or pentode section of multiple diode valves (double-diode-triode, etc.). A similar setting of this switch serves for the triode or oscillator section of frequency changers.

With the **Anode Selector** switch at position "A₂," the indicator meter will show anode current and mutual conductance associated with the second anode of double valves, the mixer anode of frequency changers and all anode systems associated with the set up figure $\frac{7}{A_2}$. In this condition the first anode is not left floating, but has the normal anode volts supplied to it via a limiting resistance.

With the **Anode Selector** set to "S", the current meter is inserted in the screen (g₂) circuit of valves and screen current will thus be indicated. When making this test, anode voltage is automatically applied to all anodes in the valve. Note that in the case of a double pentode valve, the current indicated will be the combined current of both screens.

When the **Circuit Selector** is switched to position **Rec** and **Diode**, then positions "A₁" and "A₂" of the anode selector switch correspond to diode anode 1, and diode anode 2 respectively, i.e. : to the electrodes associated with the selector switch number $\frac{8}{D_1}$ and $\frac{9}{D_2}$.

The Special Adjustment Panel at the rear of Instrument

This will be uncovered by the removable plate at the back of the instrument and the following will be exposed to view.

- (a) The coarse setting for the applied 50/60 ~ mains voltage marked 100/115, 200/215, 220/230, 240/250, the setting being made by means of the plug on this small sub-board, to the tapping most nearly corresponding to the nominal mains voltage.
- (b) The fuse holder cap which may be unscrewed revealing a small cartridge fuse which may be thus easily replaced if blown. The correct value for this fuse is 2.5 amp.
- (c) The link shorting out two sockets for the insertion of resistance, meter or other load in the anode circuit.

GENERAL PROCEDURE FOR TESTING A VALVE

1. After having set the coarse mains voltage plug at the rear of the instrument to suit the supply voltage, connect mains lead to supply noting that red and black leads are live and neutral. The green or yellow lead is the Earth connection. Switch on and note that illumination appears behind the transparent meter scale. The valve to be tested should *not* be inserted at this stage.

2. Turn the **Circuit Selector** switch to position **Check (C)** and **Electrode Leakage** switch to position "~". The instrument needle should now rise and assume a position near the black region of the insulation scale denoting zero ohms. Rotate the **Set ~** control until the meter needle assumes its nearest point to the red line in the middle of this black scale marking. With a correct settings of the initial mains voltage adjustment rotation of the **Set ~** control should enable the needle to be moved on either side of the red arrow. If this is not the case and rotation of the **Set ~** control does not enable the needle to reach its setting mark from either direction, then the initial mains setting should be moved to the next appropriate tapping. This tapping should be higher than the one chosen if the needle always appears to the right of the red mark and lower if to the left.

3. Having set up the accuracy of the instrument to conform to the applied mains voltage, refer to the "AVO" Valve Data Manual, or alternatively to the maker's characteristic data for the valve and set up the appropriate valve holder connections on the Valve Panel selector switch as already explained.

Set the heater voltage switch to its correct value for the valve and insert it in the appropriate valve holder, without moving the **Circuit Selector** switch from its position **Check (C)**. Rotate the **Electrode Leakage** switch through its various electrode positions starting with the extreme counter clockwise position marked "H". At position "H" the meter should show a short, thus indicating heater continuity. Thereafter any reading obtained on the insulation scale of the meter will show an electrode insulation breakdown corresponding to the electrode indicated by the **Electrode leakage** switch setting. (Thus a reading on the meter of 1 megohm when the **Electrode Leakage** switch is set to position "G₁" and position "S" will indicate that a cold insulation breakdown of 1 megohm is occurring between the grid and screen electrodes of the valve.) It will be noted that wherever electrode leakage occurs, indication of this will be shown at two positions of the **Electrode Leakage** switch, because, obviously, leakage must occur between two points. In the case of breakdown to heater from any other electrode, such leakage indication will only occur at one switch setting subsequent to the initial selector setting, which should automatically show zero ohms to denote heater continuity.

4. Having ensured that no cold leakage path of any magnitude is present in the valve to be tested turn the **Circuit Selector** switch to **Check (H)**. Allow a few moments for the valve

heater to warm up and note if any meter deflection occurs. Such a deflection would denote in megohms the amount of insulation breakdown that occurs between cathode and heater strapped and all other electrodes of the valve when heater voltage is applied. Note that if, for any reason, the **Circuit Selector** switch is turned back to **Check (C)** there will, in all probability, be an indication of an apparent cold electrode insulation breakdown between a number of the valve electrodes. This need not be the cause and the reading will be found generally to disappear after a few moments. The reason for such an indication is obvious when it is realised that the valve cathode has been heated during the **Check (H)** test. When returning to the **Check (C)** position, therefore, the cathode is hot and still emitting. What appears to be a temporary electrode breakdown, therefore, is in fact the indication of emission which disappears as the heater or cathode cools.

5. Turn **Circuit Selector** switch to **C/H. ins** when any cathode to heater insulation breakdown which occurs with the heater hot will be shown on the insulation resistance scale of the meter. No set rule for the rejection of a valve on this score can be laid down, but it will be realised that in many circuits where an appreciable potential exists between heater and cathode such as, for instance, in cathode follower circuits or DC valve amplifiers, the presence of a heater to cathode breakdown of the order of megohms can often give rise to quite serious trouble. Heater to cathode insulation breakdown, either permanent or variable, can also give rise to noise in valve amplifier circuits. If, on the other hand, the value of cathode to heater circuit resistance is only of the order of a few hundred ohms, as for instance where cathode biasing is used with high slope valves, then a cathode to heater insulation breakdown of the order of fractions of a megohm need not give rise to any serious trouble.

6. The next test normally to be made upon the valve is the measurement of some or all of its mutual characteristics. This may take the form of the complete plotting of one or all of its characteristics, or the measurement of its mutual conductance, or the comparative testing of the valve on the basis of its mutual conductance. All these require the manipulation of the main voltage and meter controls and, before such a test is undertaken and the **Circuit Selector** switch turned to position **Test**, one should be assured that all the requisite controls are correctly set. This applies to the setting of the anode, screen and grid voltage controls, the **Meter Selector** and the **Anode Selector** switches. *In particular, where the probable anode current of the valve is unknown, the **Meter Selector** should be set to 100mA to avoid damage to the movement, if the current flowing is such as to be considerably higher than that catered for by the lower meter range positions.* It is always perfectly simple and safe to set the **Meter Selector** at successively lower full scale current deflections to cater for a valve, the anode current of which is less than that which can be appropriately read on a higher range. If the reverse procedure is adopted, however, then it is quite possible that a damaging current may have passed through the meter circuit before the latter is set to a suitable high range. The procedure for taking the necessary valve measurements is then almost self explanatory.

Where only a measurement of mutual conductance is required then the data for this can be taken from the "AVO" Valve Data Manual. The electrode voltage settings should be made as indicated and consequent upon such settings an initial anode current will be shown on the meter which has been finally set to a suitable range. This anode current reading should normally be compared with the anode current reading shown in the tables, as it will give an initial indication of the valve "goodness". Quite obviously if a valve shows an anode current reading considerably below that which is appropriate for the applied electrode voltages, then its emission is much lower than would normally be expected and in normal circumstances the valve will not function at full efficiency. More particularly

does this apply in the case of valves used either as oscillators or output valves, for in both conditions the valve has to deliver an appreciable power which cannot obviously be up to standard if the emission is low. At the same time care should be taken not to jump to false conclusions on this basis when testing valves of very high slope and short grid base, where it may be possible to double the valve anode current for a change in bias of some .25V, and a very slight variation in the valve characteristics may give rise to an erroneous impression of the valve's "goodness" on the score of anode current. After having obtained the initial anode current reading and obtained therefrom such information as is desirable, this anode current indication may now be backed off to zero by the **Set Zero** control and the **Meter Selector** switch re-set to a range appropriate to the expected reading of mutual conductance. By pressing the **mA/V** button the mutual conductance of the valve will then be directly indicated on the meter, the reading in milliamps obtained being indicative of the mutual conductance in mA/V.

Alternatively, where it is not necessarily required to obtain a precise reading of mutual conductance, but merely a gauge of the valve's goodness factor on the basis of mutual conductance, then after backing off to zero the **Meter Selector** should be set to position **mA/V** and the **Set mA/V** control set to a value corresponding to the standard mutual conductance reading for the valve. On pressing the **mA/V** button the comparative goodness of the valve will then be shown on the coloured scale which is divided in three coloured bands. All valves coming within the green portion can be taken as satisfactory. Valves in the red portion are suitable for rejection, whilst the small intermediate band between the green and red portions denotes a valve which, whilst not entirely unsatisfactory, is not by any means working at its full rated efficiency. Subsequent action on the valves whose test figures come within this band will obviously have to be related to the particular requirement of the moment.

Where more comprehensive tests of the valve are required, to assist in the solution of development or more intricate test problems, the plotting of one or a family of mutual characteristics can often give a much more complete answer. This may readily be undertaken with the **Valve Characteristic Meter** and is performed with the **Circuit Selector** in its position **Test**. The manipulation of the controls subsequent to the obtaining of the initial anode current readings is not of course required, it being merely necessary to plot the value of the appropriate electrode currents as read from the meter, against the settings of the associated electrode voltage switches. I_a/V_{g_1} curves will be taken at a pre-determined setting of anode and/or screen volts, the reading of the anode current obtained being plotted against the settings on the variable grid bias control. Similarly I_a/V_a curves will require a fixed setting of grid bias, anode current being plotted against the settings of the anode voltage switch.

Where either mutual conductance characteristic curves are required for the screen or g_2 of the valve in question, then the **Anode Selector** switch should be set to position "S", the meter current shown will be an indication of the screen (or g_2) current and all the above instructions can be related thereto.

Remarks in relation to the tests described above as applied to multiple or special types of valve, will be found in subsequent test notes.

7. Where a valve is suspected of passing too much grid current, a measure of the magnitude of grid current at the desired conditions of applied electrode voltage may be made after having measured the mutual conductance of the valve in question. After having set the valve up and backed off the anode current to zero as for mA/V test, the button marked **Gas** should be pressed. Any grid current flowing will set up a DC grid voltage across the 100,000 Ω resistance introduced into circuit. This will result in a change in

anode current (usually forward) dependent upon the polarity of the voltage developed across the resistor. The value of the grid current flowing will then be calculated from the formula

$$I_g (\mu A) = \frac{\Delta I_a \times 10}{g}$$
—where ΔI_a is the anode current change, and g is the mutual conductance in mA/V. The direction of anode current change will denote the nature of the grid current flowing.

8. The testing of rectifying valves should really be associated with the requirements of the circuit in which these valves are to work, although in most cases, in the data for the valve in question a figure is quoted denoting the standard emission to be expected for a valve of the type under test. The procedure for carrying out the test is again straightforward. All initial tests should have been carried out as for amplifying valves, but instead of setting **Circuit Selector** to **Test** for the measurement of mutual characteristics, the circuit selector should be set to position **Rec** after having turned the **Meter Selector** to a load current range appropriate to the valve. This load current, it will be realised, applies to one anode only. The setting of load current can either be determined from the tabulated data as already mentioned, or alternatively can be related to the total current that the valve is required to deliver. Thus in a piece of apparatus where the total HT current drawn is say 50mA, then a rectifier load current setting of "60" will be an adequate test for the valve emission (assuming half wave rectification.)

Alternatively, if the valve is a new one, the maker's rating for maximum load current can be used as the basis for the setting of the meter range switch. It will be realised that since each half of a full wave valve is tested independently, then the setting of the range switch should indicate half the total value of current that the valve would be expected to deliver in a full wave circuit. For instance a valve rated at a maximum current of 120mA would be tested with each anode at the "60" position on the **Meter Selector**. No further manipulation of the electrode voltage controls is required. The heater voltage is already set whilst anode, grid and screen voltage controls are completely dis-associated from the test circuit by the setting of the **Circuit Selector** switch to **Rec**, all appropriate voltage and circuit connections also being automatically made. Having, therefore, correctly set up the valve as explained, the indication of the meter needle on the coloured scale will show the operative goodness of the valve in relation to the standard load current chosen.

Similar remarks apply to the testing of signal diode valves, with the exception that these are always tested with the **Meter Selector** at "1" and the **Circuit Selector** at position **Diode**.

INSTRUCTIONS FOR TESTING SPECIFIC VALVE TYPES

The function of a valve, as distinct from its manufacturer's type number is indicated by a symbol in the form of letters appearing at the extreme right of the test data ; thus a half wave rectifier would have the letter "R" in the function column, whilst a full wave rectifier would be designated by "RR". Similarly, diode valves will be shown by the letter "D" the number of diode elements being indicated by the number of "Ds", thus "DDD" refer to a triple diode.

The testing of *multiple diodes or rectifiers* is carried out in the manner already explained, the **Anode Selector** switch being used to select the diode or rectifier element, the emission figure for which, being indicated on the meter. It will be realised that when dealing with diodes or rectifiers A_1 and A_2 positions of the selector switch represent diode or rectifier anodes 1 and 2 respectively and correspond to figures 8 and 9 in the set up figure.

In the case of **triple diodes** since only two anode systems are normally catered for, a special procedure is adopted in the set up figure. At the position in the set up number representing the third diode the symbol † is included, the first and second diodes being indicated by 8 and 9 respectively in the normal way. The valve should now be tested normally with the selector switch set to 0 where the † appears in the set up number. This will give emission figures for diodes 1 and 2. Now rotate the **Selector Switch** rollers so that the two rollers originally set at 8 and 9 are now set to 0 and set up the position † as 8 on the selector switch. A further test with the anode selector switch at A_1 will thus give the emission of the third diode, e.g., AAB1 will be indicated in the data as 0231†0980. To test diodes 1 and 2 the set up on the roller switch will be 023100980 and diodes 1 and 2 will be tested in the normal manner. For obtaining the emission figure for the third diode the **Selector Switch** will be altered to 023180000 and the **Anode Selector** to position A_2 .

Double Triodes or Double Pentodes will be indicated by the letters "TT" or "PP" in the type column and will be tested in the normal way for each half of the valve, selection being made by the rotation of the **Anode Selector** switch to A_1 or A_2 corresponding to set up figures 6 and 7.

Combined Diode and Amplifying Valves will be represented in the type columns by "DT" and "DDT" for diode triodes and double diode triodes, whilst "DP" and "DDP" indicate diode pentodes and double diode pentodes. The testing of such valves is automatic, the amplifying section being tested first with the **Circuit Selector** switch at position **Test** and the **Anode Selector** at position " A_1 " whilst the rotation of the **Circuit Selector** switch to the **Diode** position will automatically set the instrument in readiness for testing one or both the diodes with the anode selector at A_1 or A_2 respectively, with the **Meter Selector** set to "1".

Frequency Changers of the Heptode, Hexode class employing the normal oscillator section as a phantom cathode for the mixer section are not very satisfactorily tested in two Sections, as the nature of the valve construction is such that each section is dependent on the other for its correct operation. For test purposes therefore, this valve is shown connected as an HF pentode for which, where possible, anode current and/or mutual conductance figures are given. Such valves are indicated by the letters "H" in the type column.

An exception to this class of valve is the **Octode** designated by "0" in the type column which, as will be seen from the data, is tested as if it had two separate electrode assemblies, separate data being given for each. In this case the oscillator section is tested with anode selector at A_2 and the mixer section at A_1 .

As a further test to ensure the probability of such a valve oscillating satisfactorily, an indication of failing emission will possibly give the most useful results. It will be realised that when a valve is up to standard its cathode will develop its full emission at the rated heater voltage for the valve, and any change in the cathode temperature will not result in a corresponding change in the emission. If, however, the cathode's emission is failing, then an increase or decrease in the cathode temperature will result in a noticeable change in the emission for the valve. When a valve is oscillating it tends to run into the positive grid region, and thus makes use of the full emission capabilities of the cathode. Any failing emission will limit its utility in this respect. As a subsequent test, therefore, on a valve designed to be used as an oscillator, it is helpful to note the anode current at the rated test figures with the normal heater voltage applied and then decrease the heater voltage by about 10 to 15% (the next tapping on the selector switch) for a short period. In the case of a valve with failing emission this will result in an excessive decrease in the anode current considerably greater than the percentage decrease in heater volts. Such a result would suggest that the valve will not oscillate very satisfactorily. A negligible or small decrease in anode

current (or of the same order as the heater volts change) will show that the valve is developing its full emission at the rated heater voltage, and provided that the circuit conditions are right it should oscillate normally.

Frequency Changers employing separate electrode assemblies for oscillator and mixer functions are designated by "TH" (Triode Hexode) "TP" (Triode Pentode). The separate sections of this valve are not interdependent, as in the case of the phantom cathode types, and they can thus be tested in two separate sections as a pentode or triode respectively. This arrangement is catered for in the set-up figures given, 6 corresponding to the triode section and tested with the **Anode Selector** at A_1 whilst 7 in the set up figure corresponds to the mixer section which is tested with the **Anode Selector** at A_2 . The figures to be expected from both halves of the valve are given in the tables where available, but it is often informative to apply a test for failing cathode emission to the triode or oscillator section in the manner already described.

In the case of normal triodes and pentodes (including beam tetrodes) the test procedure for which has already been fully outlined, the type column will show the symbol "T" and "P" respectively.

THE USE OF THE LINK ON THE BACK PANEL OF THE INSTRUMENT.

This link is to enable a load to be inserted into the anode circuit of the valve under test when an anode current or mutual conductance test is being performed on the electrode circuit in question. It thus enables dynamic figures for the valve or electrode system concerned to be obtained, the procedure being to remove the shorting link and insert across the sockets a resistance or other load which it is desired to include in circuit.

Tuning indicators (Magic Eyes) are tested with the controls set according to the figures given in the separate data table, using the screen switch for obtaining target voltage and inserting the anode load, shown in columns marked "Ra" by means of the link at the rear of the instrument. At the approximate bias given in the table the triode section should be at cut-off and the "eye" fully closed. On varying the grid bias to zero the "eye" should open fully and the value of anode current should be approximately that appearing in the table. In the case of double sensitivity indicators giving multiple images responding to different sensitivities, two sets of data (where possible) are given, the first set referring to the more sensitive indication.

Gaseous Rectifiers

These also necessitate the use of the link, as such valves would normally pass a damaging current if tested without suitable limiting load in the anode circuit. They are, therefore, tested not on the rectifier or diode test circuit, but with the selector switch turned to **Test**, anode voltage and representative anode current figures being given in the Valve Data columns. The value of load resistance (of suitable wattage) which must be included across the link, before the valve is tested, is shown in $K \Omega$ in the "mA/V" column (which would not normally apply to a rectifier valve). Full wave examples of this class of valve are of course tested at anode selector switch positions A_1 and A_2 .

Cold Cathode Rectifiers designated by the symbol "CCR" can be tested in a similar manner, the anode voltage, approximate anode current, and load resistance being given in the data columns as above.

Thyratrons can be checked by comparison if set up as a normal triode, with a limiting resistance included in the link, the control ratio being indicated by a comparison between the peak value of the applied anode voltage, and the setting of the grid bias control which will prevent the valve striking and passing anode current. It must be emphasised, however, that the main value of such a test is in comparison only, as the hold off grid bias value

shown on the grid bias control is only approximately half that of the bias which would normally be required to hold off the anode current of the valve at the peak anode voltage in question.

Neon Indicators may be tested for striking, by setting up the roller switch so that anode and cathode pins of the tube are set to 6 and 1 respectively, all other rollers being connected to 0. A suitable load resistance (normally between 5,000 and 15,000 ohms) should be included in the anode circuit link and the anode voltage switch should be set to a peak value as near as possible to (and in no cases lower than) the striking voltage of the neon in question. The striking of the neon will, of course, be indicated by a passage of anode current shown on the meter which should be set at a suitably high current range. It should be noted that where the anode voltage refers to the peak applied voltage, as in the case of thyratrons and neons, the actual peak voltage applied to the valve is higher than the indication on the anode voltage switch. To obtain the peak voltage equivalent to a given setting of the anode voltage switch the figure shown on the switch should be multiplied by approximately 1.5; thus with the anode voltage switch set to represent a DC voltage of 100V, the peak applied voltage is approximately 150V.

GENERAL PRECAUTIONS TO BE OBSERVED WHEN USING THE VALVE CHARACTERISTIC METER

It will be realised that when dealing with an instrument such as the Valve Characteristic Meter with such flexibility of control, it is almost impossible to protect the instrument to such an extent that the operator cannot cause damage to either the valve or the instrument by some combination or wrong setting of the controls or incorrect use of the meter. It is, therefore, important that the correct procedure, as previously outlined, should be used in the sequence of the tests applied. Valves should be tested for insulation or breakdown before full voltages are applied for characteristic tests. Where any doubt whatever exists as to the probable electrode current likely to be passed, the **Meter Selector** switch should always be turned to its highest current range and then gradually reduced in order to facilitate reading of the current.

In experimental work where a variable voltage is required to be supplied to the anode or screen electrodes of the valve, always start with the lower voltage tappings and increase only after correct adjustments have been made to the meter selector circuit to ensure that the meter circuit is not thus overloaded by an unknown current. Always make sure that the selector voltage switches have been correctly set for the valve before the instrument is switched on. In this respect it is a good practice to return the selector voltage switches to zero (particularly Heater Voltage switches) after a test has been applied and before a new valve is inserted.

Take care in setting the selector switch to avoid wrongly connecting the electrodes of the valve under test. In this respect the automatic cut-out is advantageous in that it will usually save a valve if high tension voltage is inadvertently applied to the heater by incorrect setting of the switch, but it must be pointed out that after the switch is correctly set *nothing can save the heater from being burnt out if an overload heater voltage is applied by wrong setting of the heater voltage switches.*

Do not apply test voltages to the valve without ensuring that where necessary top cap connections have been correctly made, as a valve can often be irreparably damaged by running it with its grid or its anode wrongly connected.

Where a valve appears to be performing abnormally, as indicated for instance by a continuously rising or falling anode current which does not attain a condition of stability, do not leave the valve "cooking" for a long period to see what will ultimately happen, as this will in all probability result in the damaging of the valve due to excessive currents in the anode or screen circuits. In general, it is not necessary or helpful to leave a valve on test for a considerably longer period than is necessary to complete the test in question.

Finally, it must be stressed that whilst every care has been taken in the compilation of this publication and the "AVO" Valve Data Manual to ensure that all data given is correct as far as is known at the time of going to press, it is not impossible that with the many thousands of figures involved, errors will have crept in. The manufacturers cannot hold themselves responsible for any damage that might occur to a valve or to the instrument from such a cause.

NOTES ON SIMPLE MAINTENANCE OF INSTRUMENT

If on switching on the instrument and performing the usual test for applied mains voltage, the meter needle does not indicate, and the lamps behind the movement do not light, then it can be assumed that the cut-out has operated. This can have been caused by either an internal or external short circuit that has occurred previously to switching on, or by a sharp mechanical shock that can have jolted the relay. The cut-out is reset by pushing the "reset" button.

Alternatively, the fuse may have blown.

First remove the mains plug and check the fuse for continuity and if necessary replace with Belling Lee type L.562/2.5 rated at 2.5 amps. Then replace the mains plug and re-set the cut-out. If the cut-out again blows, examine for an external short on the top panel. Failure due to an internal short circuit should be reported to the Company.

If the lamps do not light but the test for mains voltage shows a normal deflection, then one or both the lamps (they are in series) may have been blown. They should be removed after having removed the mains plug by withdrawing the mounting bracket through the aperture in the rear of the instrument and faulty lamps replaced with Osram type 6.5 volt 0.3 amp S.E.S. fitting (or equivalent).

It is highly probable that due to variations in manufacture, a number of valves will show test figures differing widely from their normal ratings. If, however, all valves appear to be reading consistently low or high by a large percentage then it is probable that either the applied voltages or the movement sensitivity are at fault.

These can be checked without opening the instrument, as follows:—

First check the grid volts between the grid and cathode sockets of a valveholder using an electronic or other D.C. voltmeter imposing negligible load. Then with any given setting of the grid voltage control, the mean D.C. reading obtained between grid and cathode sockets should be $0.52 \times$ the nominal setting of the grid control and this should be maintained over the full span of the control.

Thus with the control set at -6 volts, the valve voltmeter reading should be $-3.12V$ mean D.C., from grid to cathode.

Similarly, the pressing of the button marked mA/V should result in a positive voltage change of $0.52V$ DC.

Thus with the grid voltage set as above and the button pressed, the valve voltmeter should read $-2.6V$ i.e. $(-3.12 + 0.52)$.

Similarly, the applied anode and screen voltages may be checked by taking a reading between anode (or screen) and cathode sockets of a suitably set up valve holder with an ordinary AC voltmeter. These can be compared with the appropriate anode or screen voltage switch setting as follows :—

$$\text{Nominal voltage (D.C.) setting of switch} = \frac{\text{AC voltage apparent at Valve Holder}}{1.1}$$

Finally the accuracy of the movement may be checked by inserting a valve in the Valve Characteristic Meter correctly set up for test and introducing a suitable multirange DC milliammeter across the link on the back panel. On switching on, the current reading obtained on the Valve Characteristic movement (read in conjunction with the meter range switch) should be exactly twice the current reading on a suitable range of the milliammeter inserted into the link.

If any or all of the above relationships do not hold good after mains voltage has been correctly set, the following procedure should be adopted.

- (a) If anode or screen volts do not come within approximately $\pm 5\%$ (allowing for any possible error in the meter. N.B.—BS 1 allows $\pm 3\frac{1}{2}\%$ of f.s.d.) of the required relationship, consult manufacturer.
- (b) If variable grid voltage does not compare with correct V.V. reading :—Remove case of instrument and adjust control marked V.G. on small sub-panel on frame of instrument.
- (c) If a wrong voltage change is obtained when pressing button marked mA/V—adjust pre-set control marked G.M. until correct change obtained.
- (d) Wrong relationship between panel movement and external milliammeter—adjust pre-set control marked "S", and then recheck mains setting, electrode voltages and meter sensitivity.

When making test measurements as described above, it is of course essential for the user to assure himself that he is not misinformed as to the accuracy of his Valve Characteristic Meter by the use of unsuitable or inaccurate external test instruments. Thus when measuring grid volts, the DC Valve Voltmeter used should have an input resistance of at least 100 times the internal resistance of the grid voltage circuit (which is 20,000 Ω), whilst when checking for accuracy of screen voltages, it must be remembered that a subsidiary rectifier (see page 12) is always in circuit, and thus an AC Voltmeter having a resistance not less than 1,000 Ω per volt should be used. The accuracy of all similar measurements should be related to the probable error in the measuring instrument which should of course always be high grade.

Enclosed within this publication will be found a quick reference guide to the operation of the Valve Characteristic Meter which is intended only to be used once the instructions within this book have been assimilated.

COPYRIGHT:

No information or diagrams in whole or in part may be copied or reproduced without the prior permission in writing of The Automatic Coil Winder & Electrical Equipment Co. Ltd.

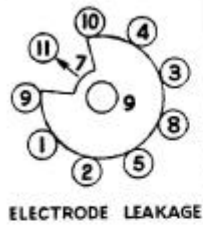

ELECTRODE LEAKAGE

- H+ →
- C H- →
- CHECK (C) →
- CHECK (H) →
- C/H INS →
- TEST →
- DIODE →
- REC →

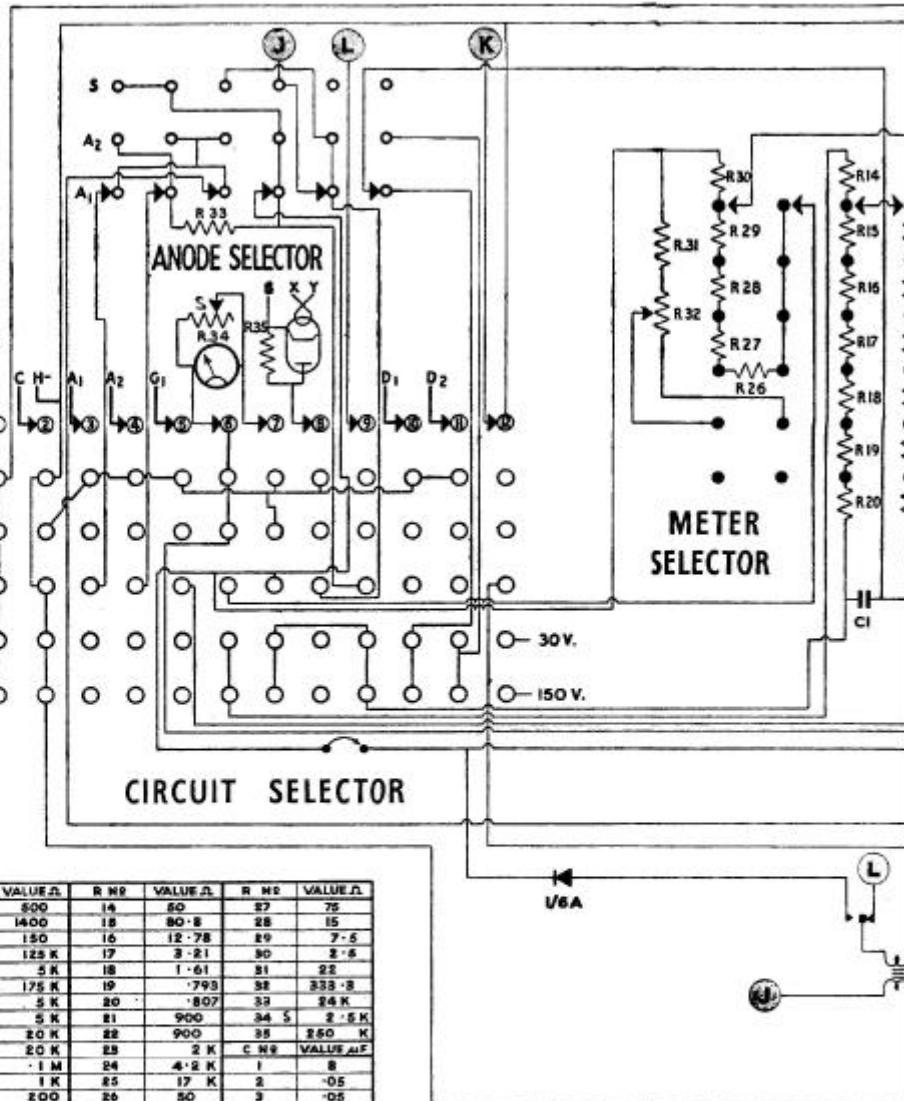

R NO	VALUE Ω	R NO	VALUE Ω	R NO	VALUE Ω
1	500	14	50	27	75
2	1400	15	80·8	28	15
3	150	16	12·78	29	7·5
4	125 K	17	3·21	30	2·8
5	5 K	18	1·61	31	22
6	175 K	19	·793	32	333·8
7	5 K	20	·807	33	24 K
8	5 K	21	900	34	2·5 K
9	20 K	22	900	35	260 K
10	20 K	23	2 K	C NR	VALUE μF
11	·1 M	24	4·2 K	1	8
12	1 K	25	17 K	2	·05
13	200	26	50	3	·05

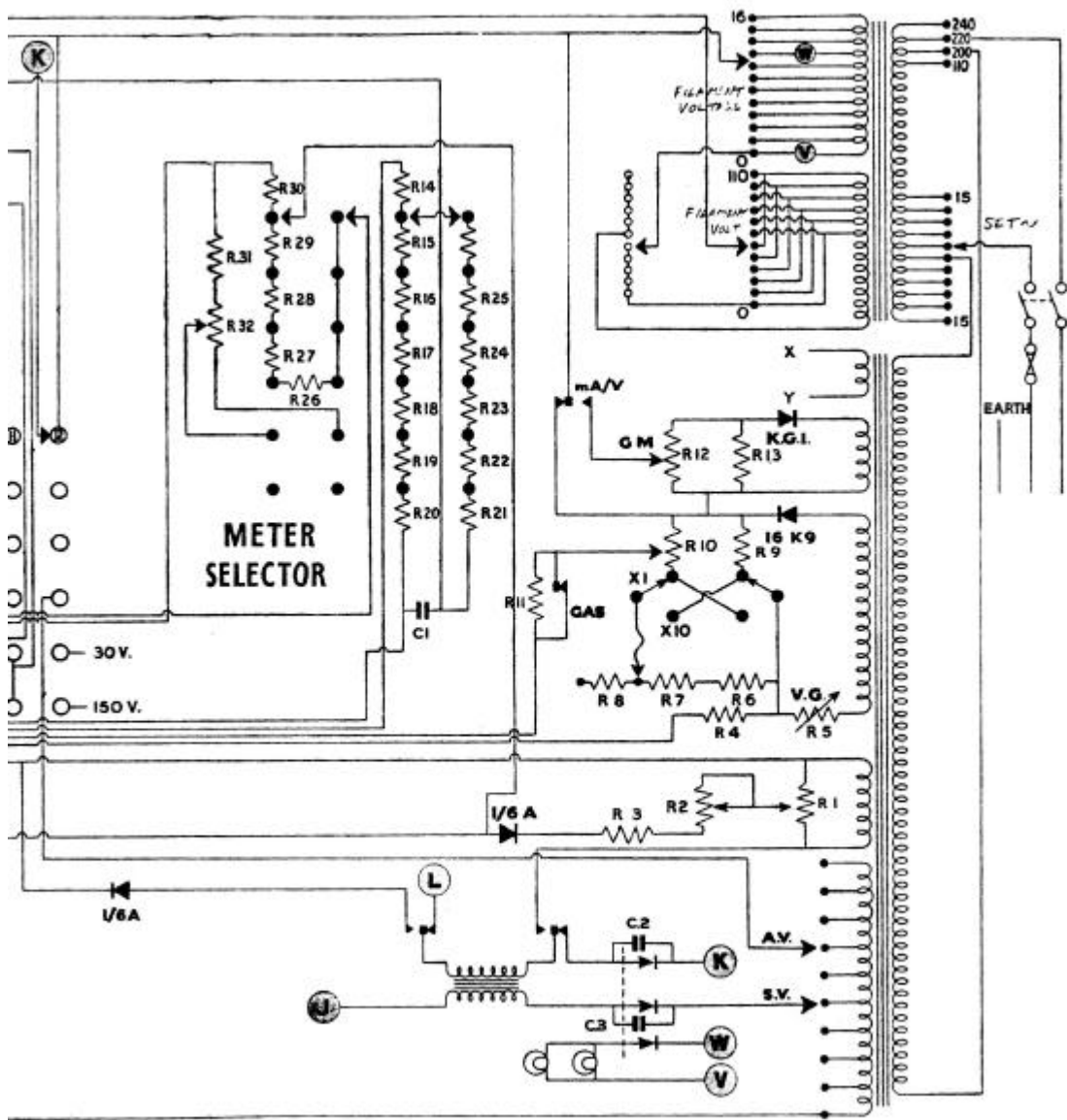

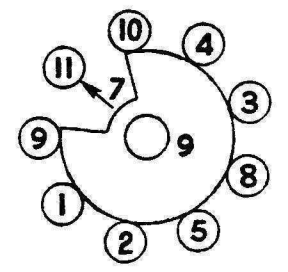

ELECTRODE LEAKAGE

- CHECK (C) — H+ — 1
- CHECK (H) — C — 2
- C/H INS — H- — 3
- TEST — A1 — 4
- DIODE — A2 — 5
- REC — G1 — 6
- D1 — 7
- D2 — 8

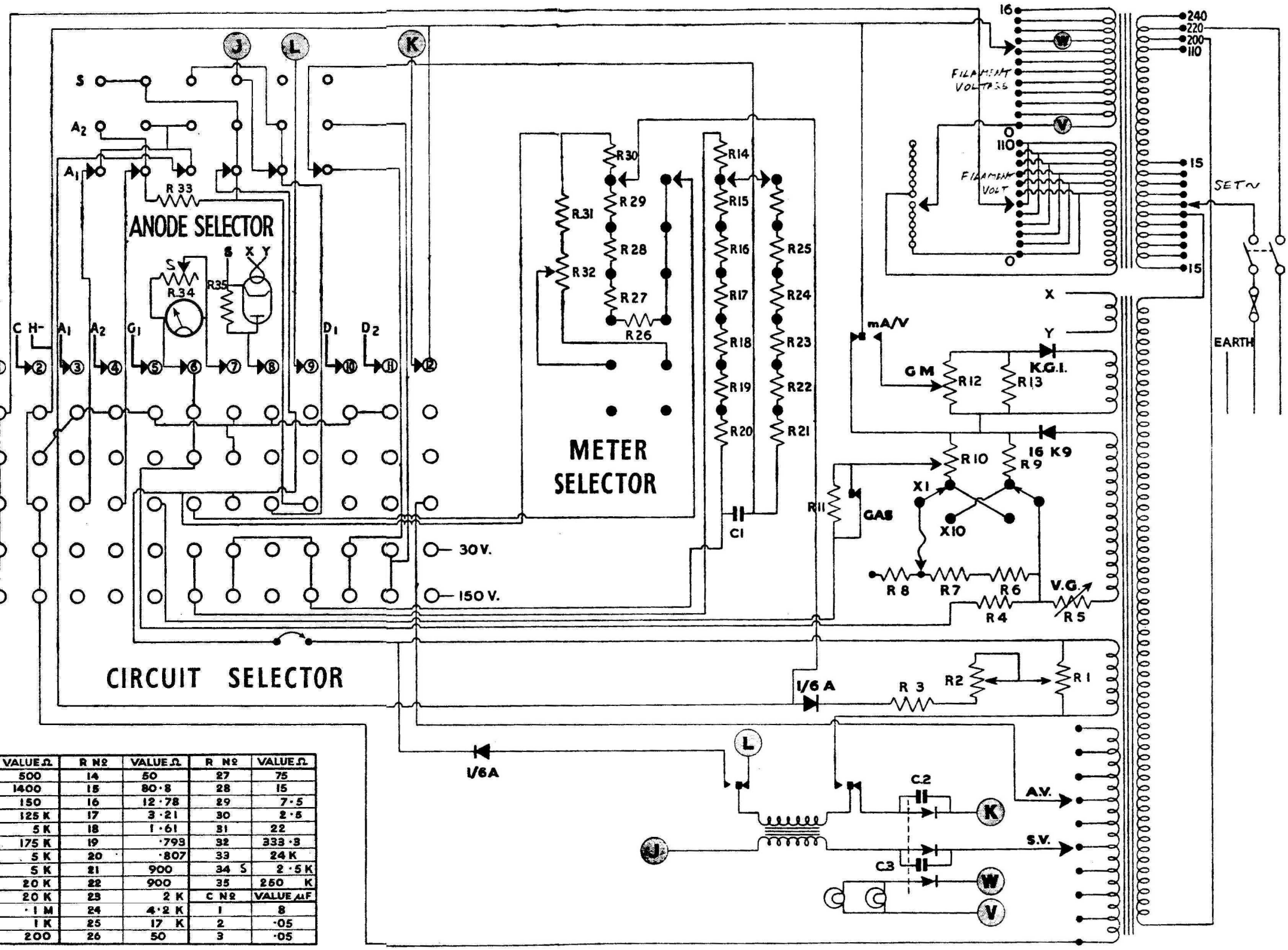

R N ^o	VALUE Ω	R N ^o	VALUE Ω	R N ^o	VALUE Ω
1	500	14	50	27	75
2	1400	15	80.8	28	15
3	150	16	12.78	29	7.5
4	125 K	17	3.21	30	2.5
5	5 K	18	1.61	31	22
6	175 K	19	.793	32	333.3
7	5 K	20	.807	33	24 K
8	5 K	21	900	34 S	2.5 K
9	20 K	22	900	35	250 K
10	20 K	23	2 K	C N ^o	VALUE μF
11	.1 M	24	4.2 K	1	8
12	1 K	25	17 K	2	.05
13	200	26	50	3	.05

AVO Mk II Valve Tester